





EUROPEAN CENTRAL BANK

EUROSYSTEM

Philipp Hartmann  
Acting Director General Research  
and MaRs Chair

in collaboration with MaRs Coordinators,  
Secretaries and Contributors

# Results of the ESCB Macro-prudential Research Network (MaRs)

Concluding Conference of the Macro-prudential Research Network  
European Central Bank, Frankfurt am Main, 23 June 2014

## ➤ Non-linear impact of widespread financial instability on growth

- Bayesian vectorautoregression model with output growth, inflation, interest rate and credit growth allowing feedback effects between all variables (monthly data, 1987-2010)
- Incorporate **Composite Indicator of Systemic Stress (CISS)** in it (see slide 12)
- Add **Markov-Switching**/regime changes in parameters and error variances

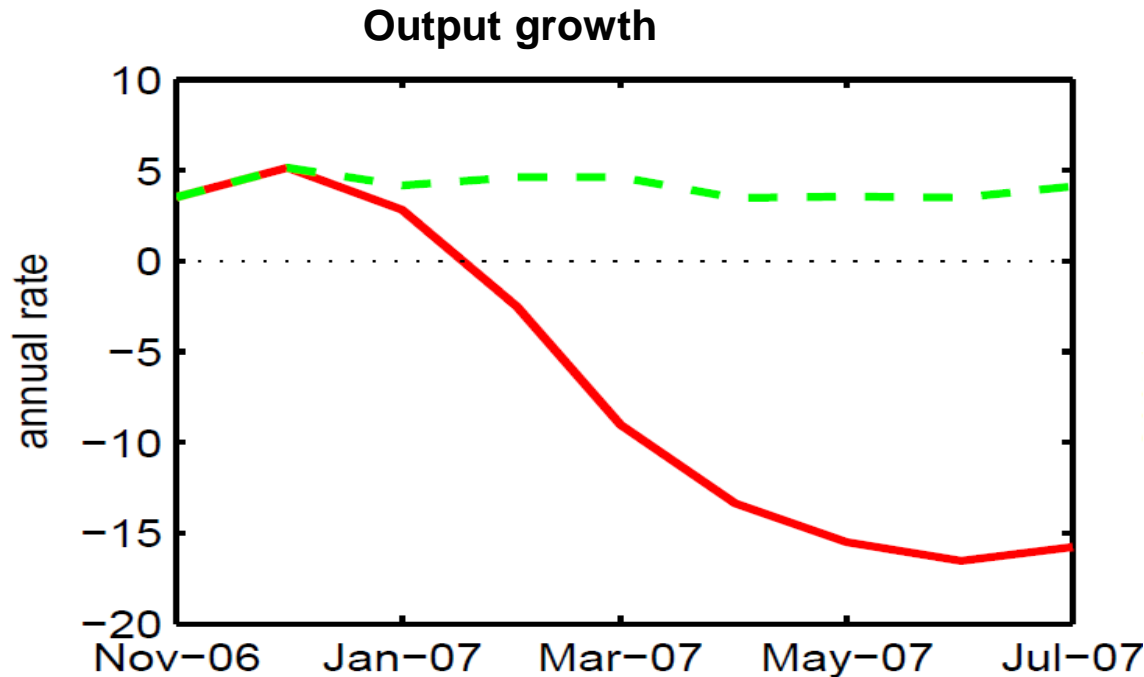

Scenario in January 2007:

What would have been the growth outlook for the euro area if **systemic instability** had hit?

- Large increase of CISS (to 0.7)
- Fundamental regime change in the macroeconomy

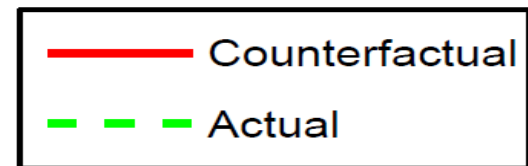

- One caveat: This scenario not “out of sample”, but possible in the future

*Source: Hartmann, Hubrich, Kremer and Tetlow (2012).*

## ESCB network established in 2010 by the General Council

- Mandate: develop core conceptual frameworks, models and tools that provide research support to improve macro-prudential supervision in EU
- Three work streams
  1. Macro-financial models linking financial stability and the performance of the economy (WS1)
  2. Early warning systems and systemic risk indicators (WS2)
  3. Assessing contagion risks (WS3)

## Output

- 161 individual research papers (WS1 – 65, WS2 – 51, WS3 – 45)
- 72 ECB Working Papers so far (WS1 – 32, WS2 – 27, WS3 – 13)
- 50 published in journals so far (WS1 – 21, WS2 – 18, WS3 – 11), including *Journal of Financial Economics*, *Economic Journal*, *Journal of Monetary Economics*
- 3 large joint cross-country projects
- 3 large public conferences: October 2011, October 2012 and June 2014

# Outline of the presentation

**1** General overview of MaRs

**2** For each work stream:

**a** Summary of research highlights and policy conclusions

**b** Research examples (cross-country projects, operational tools)

**3** Concluding remarks

- Only a very small share of total MaRs work can be shown today
- Comprehensive summary in “**Report on the Macro-prudential Research Network**” released on the ECB website now
- No survey of the outside literature (see report and papers)

## ➤ Research progress

- Several approaches incorporating **financial instability** in macroeconomic models
  - Perhaps main challenge in economics today (brief survey Hartmann et al. 2013)
  - Imbalances for bank assets and liabilities (**liquidity!**, see next slides)
  - Economy behaves fundamentally differently at systemic instability (incl. **non-linearities**, see example on slide 3 and in background slides)
  - Recessions more severe in crises where **bank credit** plays important role
  - Modelling **financial instability** rather than frictions makes material difference for macroeconomy
- Shadow banking/securitisation, expectations about real-estate prices (e.g. no rational expectations) and foreign currency loans amplify credit and **leverage cycles**
- **Cross-country spillovers** from regulator policies may be material

## ➤ Analytical tools

- Macroeconomic reference model for assessing macro-prudential regulatory policies (see later slide 9)
  - Developed by staff from 4 NCBs, ECB and MaRs consultant — Shared across the ESCB
- Non-linear empirical model for assessing macro impact of financial crises (slide 3)
  - Nowcasting states of systemic fragility, scenario analyses and, may be, forecasting

## ➤ Build-up and unravelling of imbalances via banks' asset side

- Calibrated dynamic stochastic general equilibrium model with banks that can hold a bubble asset like in the rational bubbles literature and face occasionally binding capital constraints
- Credit constraints of firms and banks decrease interest rates and lead to “search for yield”
- Banks start to hold “zero-dividend” asset in pure expectation that its value will appreciate

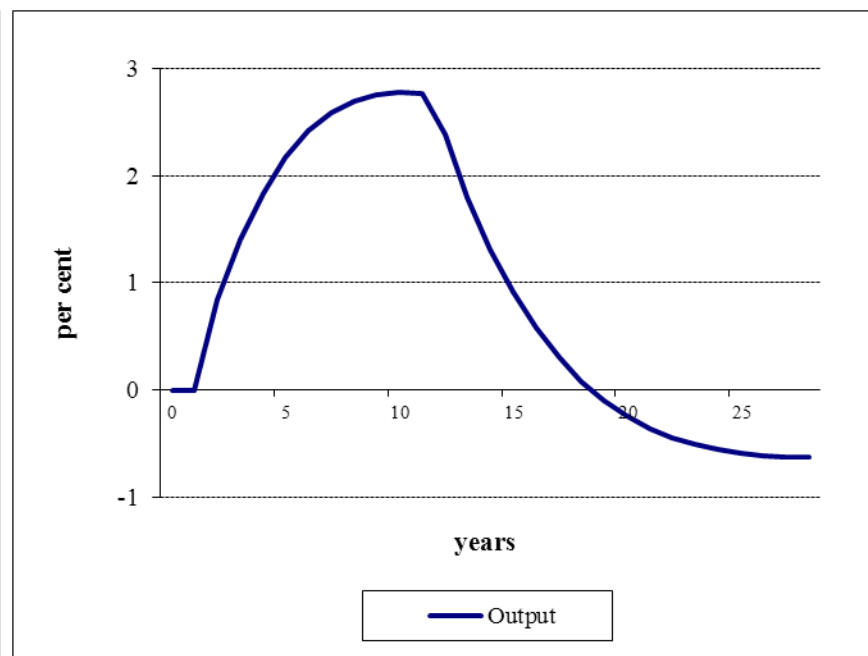
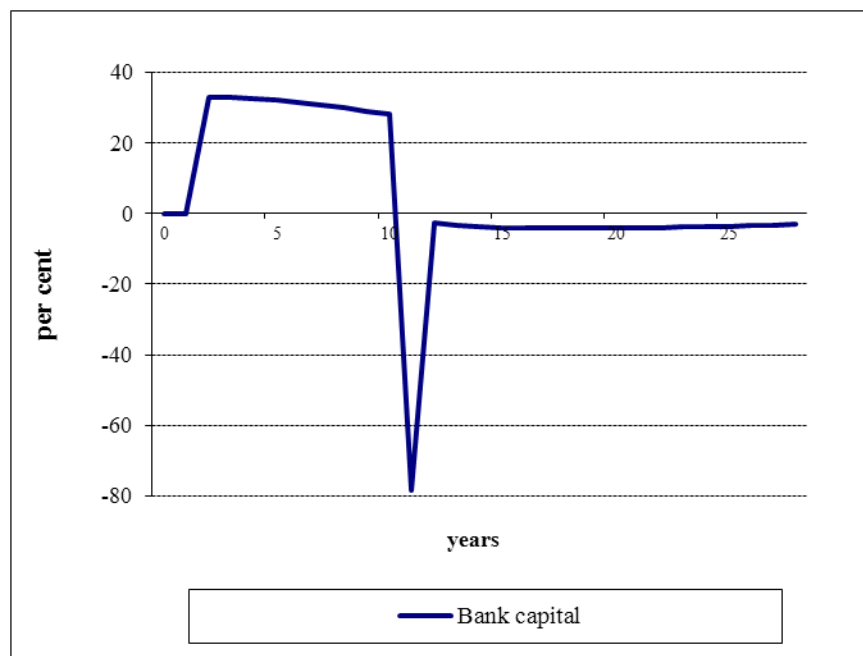

- Crisis driven by (exogenous) switch between multiple equilibria (non-linearity), one where the zero-dividend asset has value and one where it has not

*Source: Aoki and Nikolov (2012).*

## ➤ Build-up and unravelling of imbalances via banks' liability side

- Calibrated real business cycle model with banks of different ability to choose borrowers (asymmetric information)
- Positive productivity shock creates demand for loans, banks take wholesale funding and grow
- Less proficient banks enter until trust breaks down and the interbank market freezes

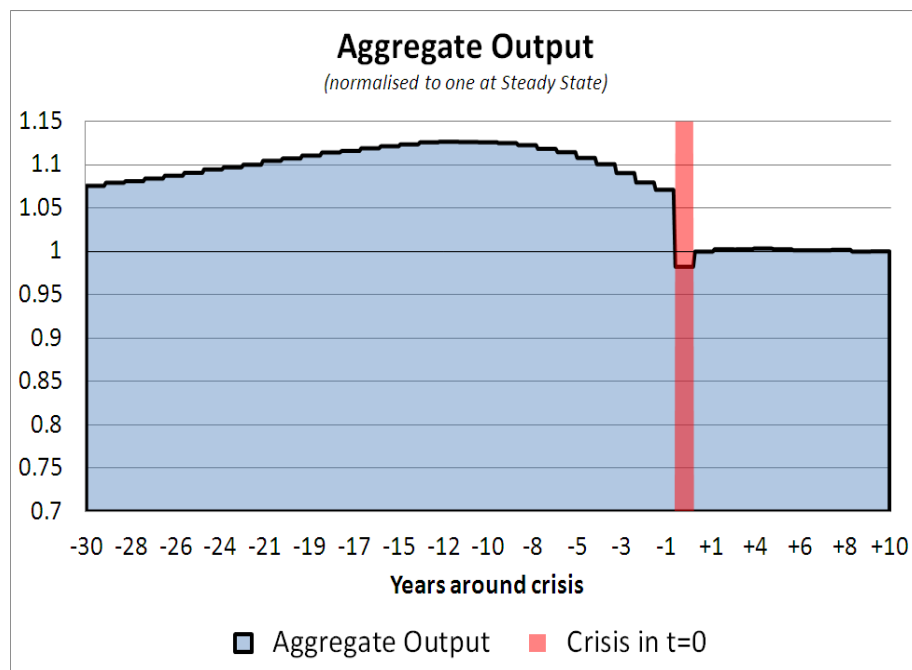
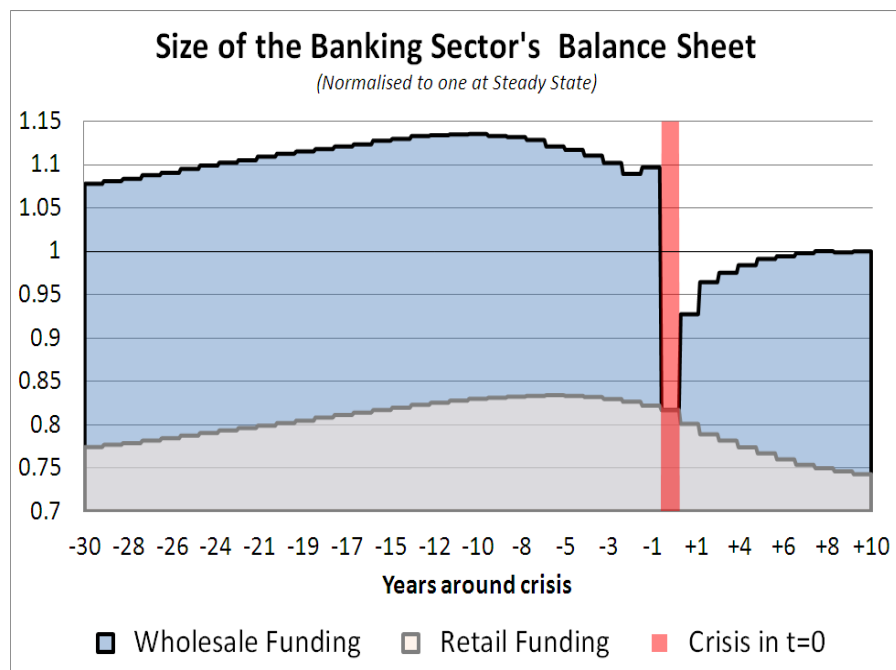

- Crisis driven by breakdown of wholesale funding (non-linearity) can emerge endogenously

Source: Boissay, Collard and Smets (2013).



# WS1: Joint cross-country project leading to a shared tool

## ➤ Macroeconomic reference model for assessing macro-prudential regulatory instruments, capturing their **benefits and costs**

- Financial instability: central role of default (**bank default**, **firm default**, **HH default** – **3D**)

- Sources of systemic risk

- Imbalances (over-lending due to excessive bank risk-taking)
- Aggregate shocks (amplified through bank capital reduction and higher bank funding costs)
- Some interbank contagion (through bank funding costs)

- Present focus on capital adequacy policies

- **Steady state** capital requirements
- **Counter-cyclical** capital buffers

- Higher capital requirements

- **Correct risk-taking incentives**: reduce excessive lending and defaults
- **Tighten credit supply**

Social Welfare Gains (in terms of consumption) from increasing the Capital Ratio

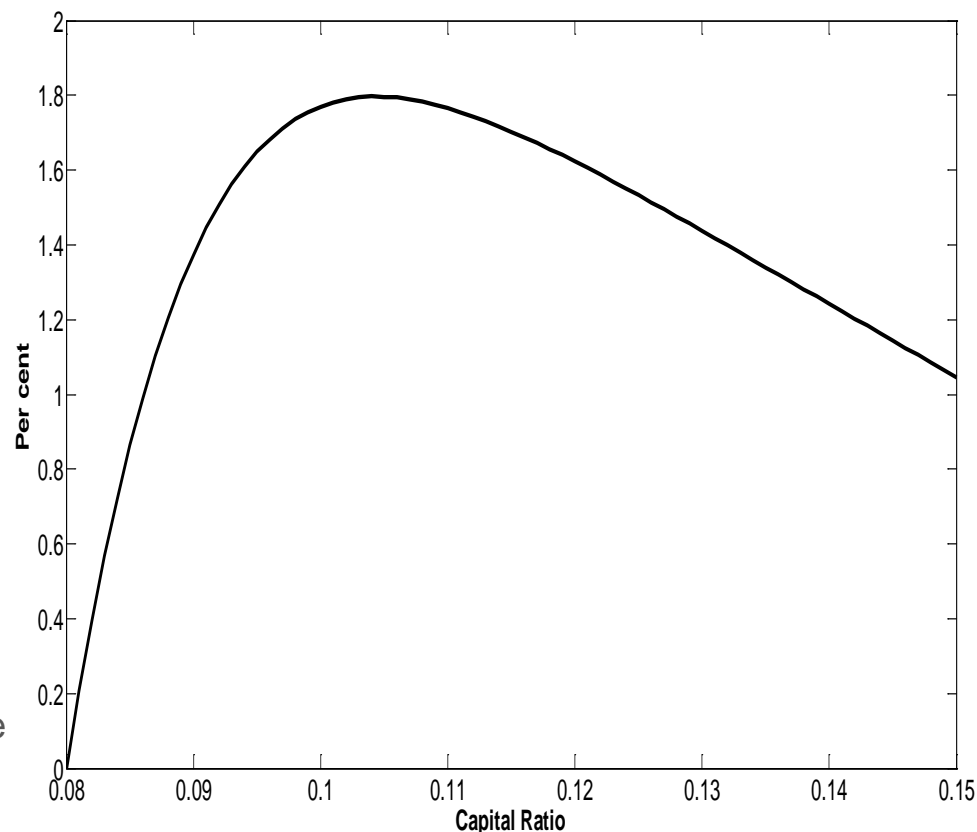

Source: Clerc (BdF), Derviz (CNB), Mendicino (BdP), Moyen (Bundesbank), Nikolov, Stracca (both ECB), Suarez (CEMFI) and Vardoulakis (ECB and Fed Board, 2014).

## ➤ Macro-prudential policy

- Multitude of market imperfections that contribute to systemic risk require multiple regulatory instruments:
  - Key to diminish **fire-sale** risk
  - Regulatory arbitrage may require capital requirements to be combined with margin requirements on repos
- But indiscriminate combinations of regulations can also be counterproductive
- Countercyclical loan-to-value ratios (LTVs) more effective than static ones (politically complex, but perhaps generalised collateral limit could help)
- Advisable to consider LTVs and debt-to-income limits (DTIs) together
- Regulatory policies may need to be coordinated across financially integrated countries (roles of Single Supervisory Mechanism, ESRB), also for instruments outside EU legislation (LTVs, DTIs!)
- Interaction with monetary policy
  
- Descriptive work by the CGFS, ESRB and IMF on macro-prudential policy instruments

## ➤ Research progress Early Warning Models (EWMs)

- **Evaluation methodologies:** taking into account policymaker's relative aversion against missing crises and false alarms and checking robustness across range of thresholds (AUROC=Area under the receiver operating characteristic)
- **Variable selection methodologies:** Bayesian model averaging; bootstrapping (random forests, see slide 14); principal components; should all improve out-of-sample performance of models
- **Visualisation** of EWM results for policy purposes: Decision trees; self-organising maps

## ➤ Analytical tools

### Early warning models:

- **Univariate signalling** approach
- **Multivariate logit/probit** (also including random coefficient models)
- **Decision trees** (binary classification trees, see slide 14)
- **Bayesian model averaging**

### Systemic instability indicator:

- **CISS:** aggregates stress indicators for the main financial markets and institutions (broad coverage of financial system) taking into account their dependence and relation to real economy (next slide); useful e.g. in guiding the release phase of the countercyclical capital buffer

## ➤ Composite Indicator of Systemic Stress (“CISS”)

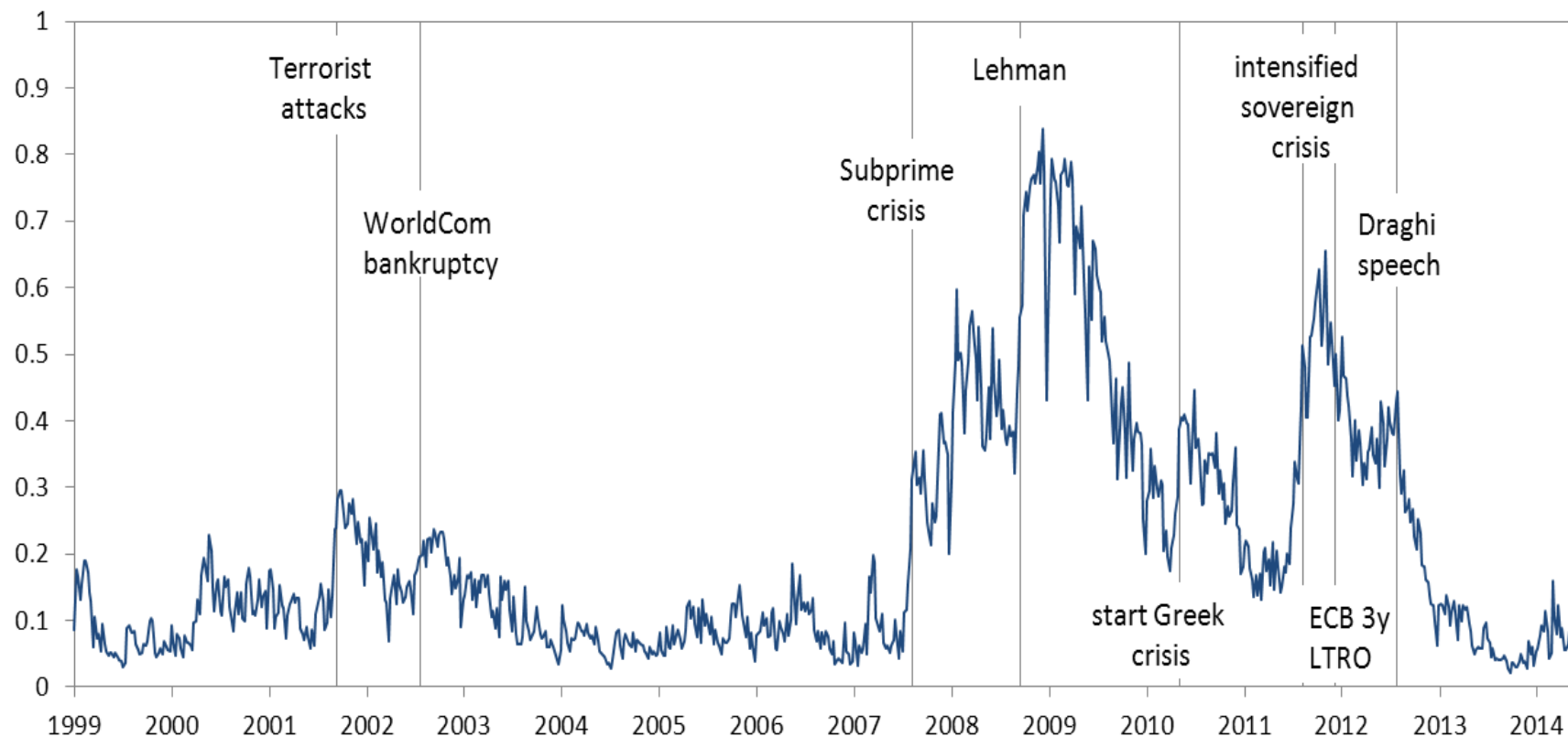

- Scope: Equity, bond, money and FX markets plus banks/financial institutions - **real time**
- Basic sub-measures include volatilities, trends, spreads, recourse to marginal lending (weekly data)
- Normalisation between 0 and 1 and aggregation weighted with correlations (“systemic”)

*Source: Holló, Kremer and Lo Duca (2012).*

- **“Horse race”**: Exercise set up to compare in a systematic way alternative EWMs for systemic banking crises in the EU
  - **Common dataset** of systemic banking crises in EU countries collected by MaRs researchers and other ESCB staff with the help of Heads of Research (Babecký et al. 2012)
  - **Harmonised explanatory data** (as much as possible)
  - **Common rules** of the game (e.g. prediction horizon 1-5 years ahead, recursive de-trending, pseudo-real time data)
  - **Common evaluation** method
  - **Nine teams** from **seven NCBs and the ECB** participated (next slide one example: decision tree based on random forest)

# WS2: Example of a tool for identifying vulnerable banking systems

## ➤ A decision tree for signalling systemic banking crises (1-5 yrs ahead)

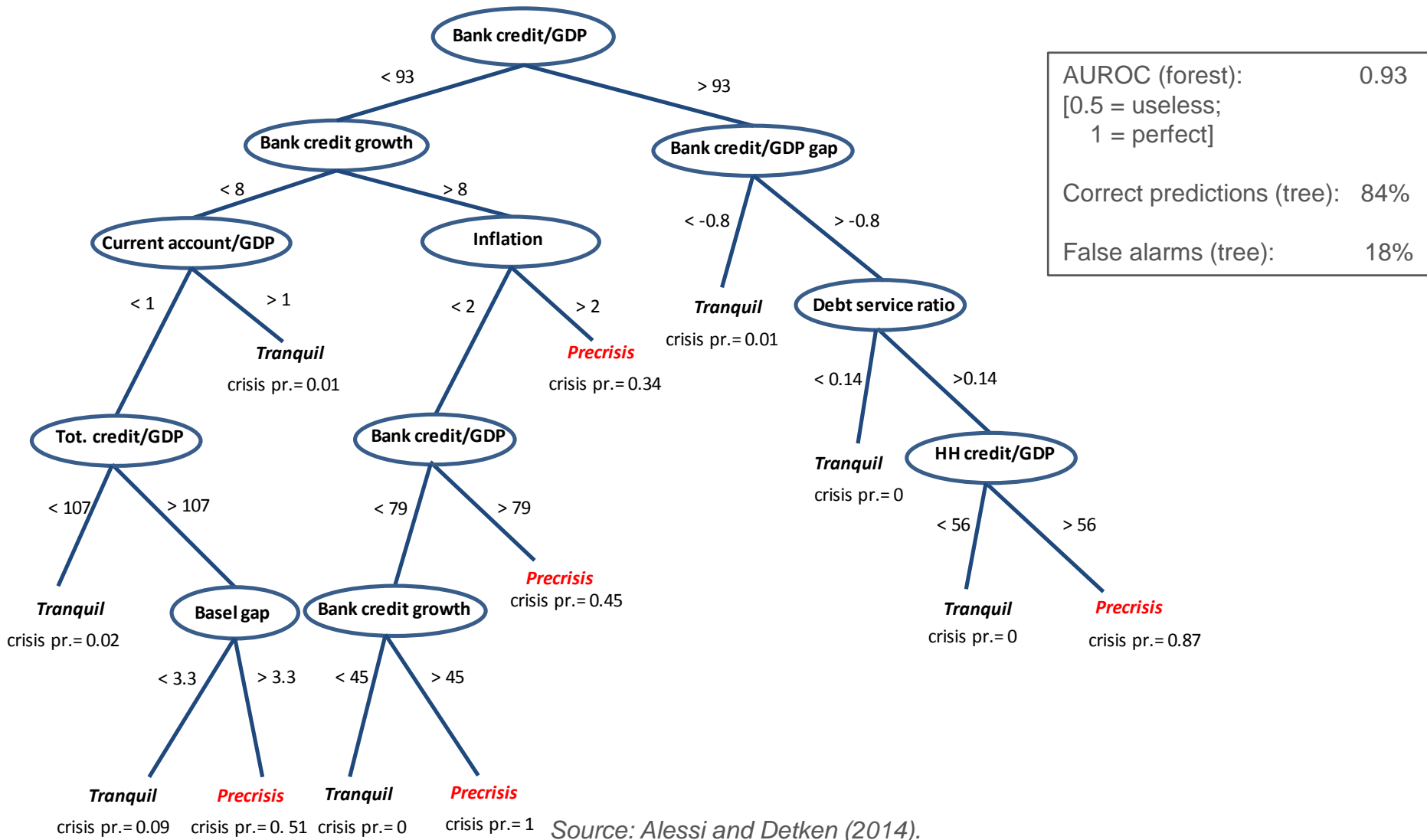

AUROC (forest):	0.93
[0.5 = useless; 1 = perfect]	
Correct predictions (tree):	84%
False alarms (tree):	18%

Source: Alessi and Detken (2014).

## ➤ Policy advice (for building a robust early warning system)

- No single model dominating across all evaluation criteria and policy makers’ preferences. A **suite of models** recommended; best models, indicators and especially (optimal) triggers strongly dependent on policy makers’ preferences
- **Credit is key indicator** (credit/GDP gaps, credit growth) but other indicators also useful: proxies for asset (housing) price misalignments, CA/GDP, Debt-service-to-income ratios; global indicators and interaction terms, bank leverage. (See also Detken et al. 2014)
- **Multivariate models** outperform single credit and housing indicators by conditioning credit developments and adding time dependency and contagion/herding information [best AUROCs 0.9 (univariate 0.8), false alarms 10-30% (univariate 35%); correct predictions for univariate and multivariate 80-86%]

→ Support for overcoming “this-time-is-different syndrome”

## ➤ Research progress

- Several **contagion mechanisms** analysed: default cascades, marginal contagion (see slide 17), payment delays, contagion versus integration
- Sources of **amplification and non-linearities** identified
- Two-sided nature of **interbank relationships**: can ensure funding sources during crisis times or act as a conduit for contagion
- Analysis of **time-varying spillovers** in interbank rates (fragmented versus integrated times, stressed versus non-stressed countries)
- Substantial further evidence of **sovereign contagion** (e.g. through statements questioning commitment to support weak sovereigns), although debate on alternative explanations continues (fundamentals and risk aversion)

## ➤ Analytical tools

- Construction of **data base of interbank loans/exposures** from TARGET2 transaction-level data using Furfine (1999) algorithm (effort 15 researchers from 11 NCBs with payment experts in a large joint cross-country project; Arciero et al. 2013, de Frutos et al. 2013 – ESRB efforts with different data)
- Default simulation model with amplification through **asset fire sales**
- Indicators of **money market stress/fragmentation** (see slide 18)
- New TARGET2 data base and infrastructure opens up an enormous range of opportunities for macro-prudential surveillance and assessment tools (but also other areas)



## ➤ Effect of bank failure on euro interbank network (example Dec. 08)

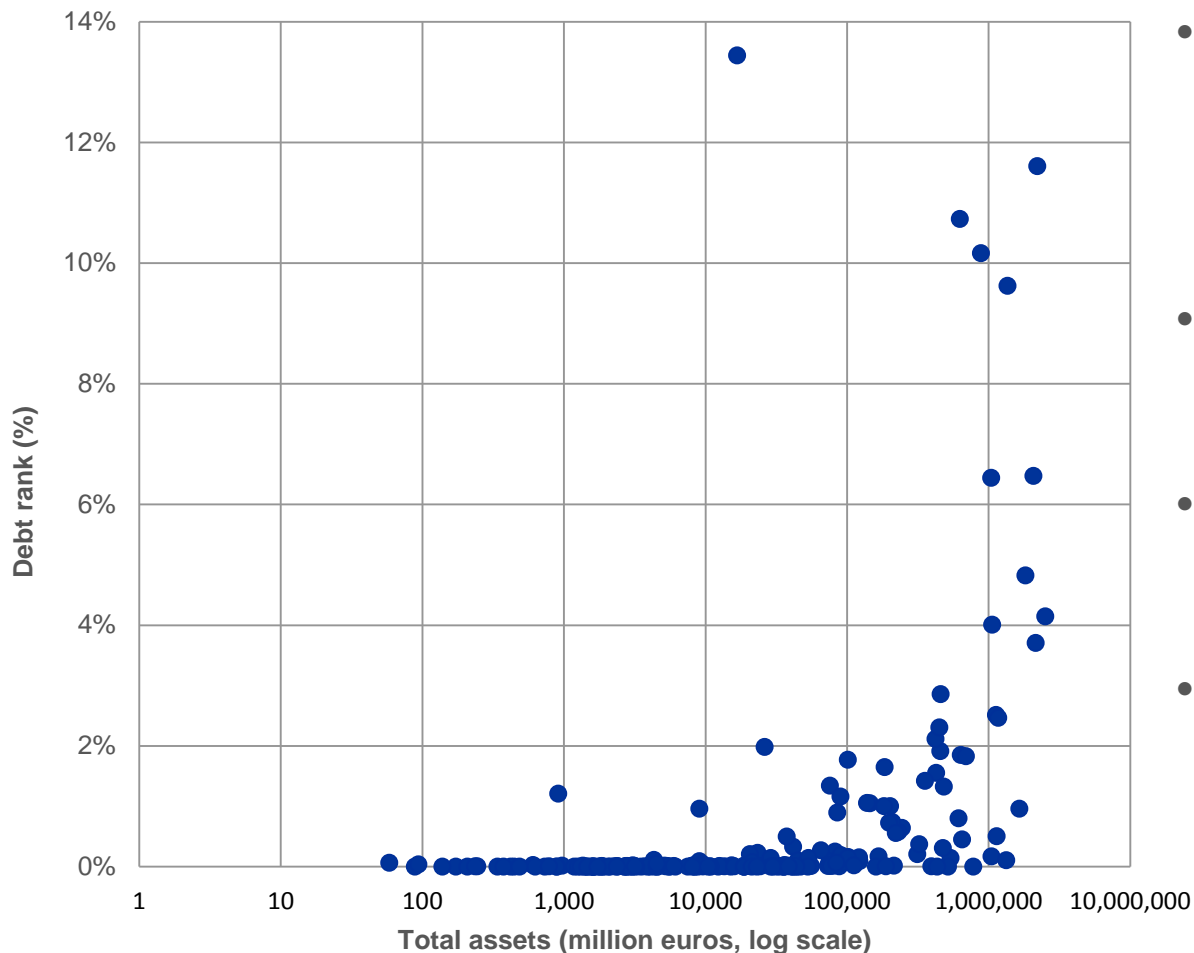

- Transmission not only through defaults but also proportional to Furfine exposures, relative losses and relative capitalisation of banks
- Contagion risk larger than found in traditional default simulations
- Largest banks have systemic effect (non-linear) but wide dispersion
- Helps, inter alia, to understand the systemic importance of individual banks and how it evolves over time

*Simulation of the overall loss of equity (in % of total) among all banks active in TARGET2 caused by individual bank failures (“debt rank” methodology based on a further development of Battiston et al. (2012)) and bank size.*

*Source: di Iasio, Rainone, Rocco and Vacirca (2013).*

## ➤ Impact of bank geographical location on the price of euro liquidity

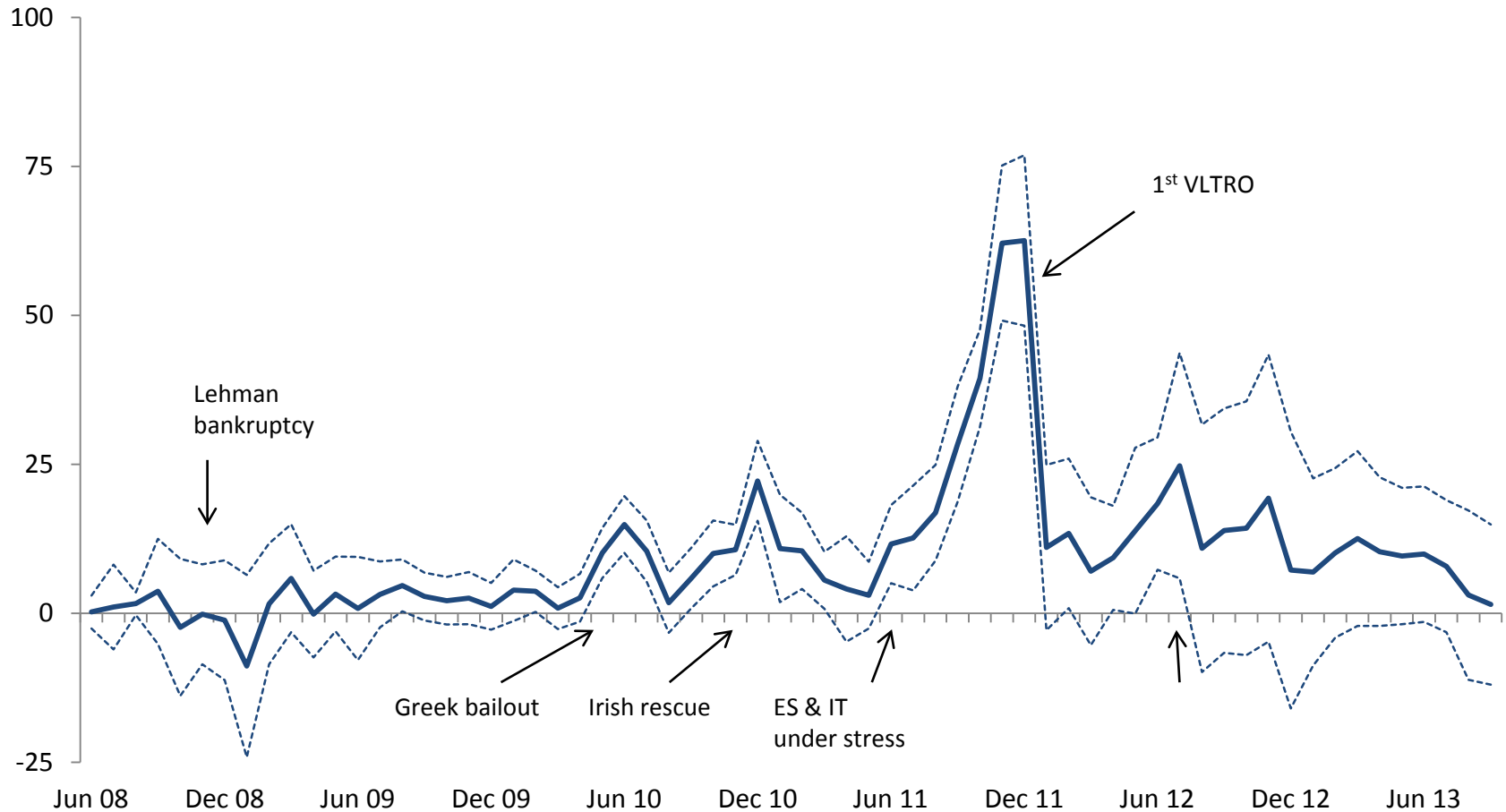

*Estimated average country risk premium that banks from five stressed euro area countries pay on euro overnight loans after controlling for their own risk in a panel regression with monthly data.*

*Source: Garcia, Hoffmann and Manganelli (2013).*

# Concluding remarks 1

- State of macro-prudential policy and research before MaRs
- Network has made significant progress within its mandate
  - Further clarified important **concepts**
  - Developed several **structural models** integrating financial instability into macro (perhaps main challenge of economics today)
  - Proposed a variety of novel **empirical approaches** to
    - **measure widespread financial instability and identify its origins**
    - assess its (often non-linear) interaction with the economy at large
    - warn about the risks of crises
  - Started to assess a range of **regulatory instruments** for macro-prudential purposes
  - Developed a number of **analytical tools** for supporting policy
  - Put new (European) **data sources** at work
- Parallel efforts by other authorities (e.g. BIS, IMF, Fed) and academia

# Concluding remarks 2

- Desirable that some directions (also emerging in some parts of academia) are also adopted more widely in the economics profession
- May require an additional macroeconomic paradigm (Ph.D.s for central bank recruitment, teaching of undergraduates)
  
- What's next?
  - Plan of an annual macro-prudential conference
  - Including models and tools for operational use in committees supporting decision-making bodies, maintaining and developing them further
  - Smaller, targeted efforts at the federal level

*Mehr Gutes  
hat nicht reingepasst!*

Schokolade

Karamell

Milch

Nuss

Kakao-Creme

*...!*

**Mars**

Nimm Mars, gib Goal

OHNE KUNSTLICHE ERWEITERUNGSMITTEL  
KONSERVIERUNGSMITTEL

# Background Slides

# MaRs and internal references in the presentation 1

- Alessi, L., & Detken, C., 2014, Identifying excessive credit growth and leverage, ECB, *Mimeo*.
- Aoki, K., & Nikolov, K., 2012, Bubbles, banks and financial stability, ECB, *Working Paper Series*, 1495.
- Arciero, L., Heijmans, R., Heuver, R., Massarenti, M., Picillo, C., & Vacirca, F., 2013, How to measure the unsecured money market? The Eurosystem's implementation and validation using TARGET2 data, *DNB Working Papers*, 369.
- Babecký, J., Havránek, T., Matějů, J., Rusnák, M., Šmídková, K., & Vašíček, B., 2012. Banking, debt and currency crises: Early warning indicators for developed countries, ECB, *Working Paper Series*, 1485.
- Boissay, F., Collard, F., & Smets, F., 2013, Booms and systemic banking crises, ECB, *Working Paper Series*, 1514.
- Clerc, L., Derviz, A., Mendicino, C., Moyen, S., Nikolov, K., Stracca, L., Suarez, J., Vardoulakis, A., 2014, Capital regulation in a macroeconomic model with three layers of default, ECB, *Mimeo*.
- de Bandt, O., Hartmann, P., & Peydró, J.L., 2010, Systemic risk: An update, in A. Berger et al. (eds.), *The Oxford Handbook of Banking*, Oxford University Press, 633-672.
- de Frutos, J., de Andoain, C. G., Heider, F., & Papsdorf, P., 2013, Stressed interbank market: Evidence from the European financial and sovereign debt crisis, ECB, *Mimeo*.
- di Iasio, G., Rainone, E., Rocco, M., & Vacirca, F., 2013, A short note on contagion in the euro area money market, Banca d'Italia, *Mimeo*.
- European Central Bank, 2009, The concept of systemic risk, *Financial Stability Review*, December, 134-142.

# MaRs and internal references in the presentation 2

- European Central Bank, 2010, Analytical models and tools for the identification and assessment of systemic risks, *Financial Stability Review*, June, 138-146.
- European Central Bank, 2012, Report on the first two years of the Macro-Prudential Research Network, October.
- European Central Bank, 2014, Results of the Macro-Prudential Research Network (MaRs), Frankfurt am Main, June.
- Garcia de Andoain Hidalgo, C., Heider, F., & Rünstler, G., 2013, The euro area money market network during the financial crisis: A look at cross-border fragmentation, ECB, *Mimeo*.
- Garcia de Andoain Hidalgo, C., Hoffmann, P., & Manganelli, S., 2013, Fragmentation in the euro area interbank market, ECB, *Mimeo*.
- Hartmann, P., Hubrich, K., Kremer, M., & Tetlow, R. J., 2012, Melting down: Systemic financial instability and the macroeconomy, ECB, *Mimeo*.
- Hartmann, P., Hubrich, K., & Kremer, M., 2013, Introducing systemic financial instability into macroeconomics: How to meet the challenge?, ECB, *Research Bulletin*, 19, 2-9.
- Holló, D., Kremer, M., & Lo Duca, M., 2012, CISS - A composite indicator of systemic stress in the financial system, ECB, *Working Paper Series*, 1426, March.
- Trichet, J.C., 2011, Intellectual challenges to financial stability analysis in the era of macroprudential oversight, Banque de France , *Financial Stability Review*, 15, February, 139-149.



# External references in the presentation

- Admati, A. R., & Hellwig, M. F., 2013, *The Bankers' New Clothes: What's Wrong with Banking and What to Do About It?*, Princeton University Press.
- Battiston, S., Puliga, M., Kaushik, R., Tasca, P., & Caldarelli, G., 2012, DebtRank: Too central to fail? Financial networks, the FED and systemic risk, *Scientific Reports* 2, 541, 1-6.
- Breiman, L., 2001, Random forests, *Machine Learning*, 45(1), 5-32.
- Detken, C., et al., 2014, Operationalising countercyclical capital buffers, ESRB Occasional Paper, forthcoming.
- Furfine, G., 1999, The microstructure of the federal funds market, *Financial Markets, Institutions, and Instruments*, 8(5), 24-44.
- Martinez-Miera, D., & Suarez, J., 2012, A macroeconomic model of endogenous systemic risk-taking, CEMFI, *Mimeo*.
- Miles, D., Yang, J., & Marcheggiano, G., 2012, Optimal bank capital, *Economic Journal*, 123(567), 1-37.
- Ota, T., 2013, Marginal contagion: A new approach to systemic credit risk, Bank of England, *Mimeo*.

# WS1: Structure of the 3D model

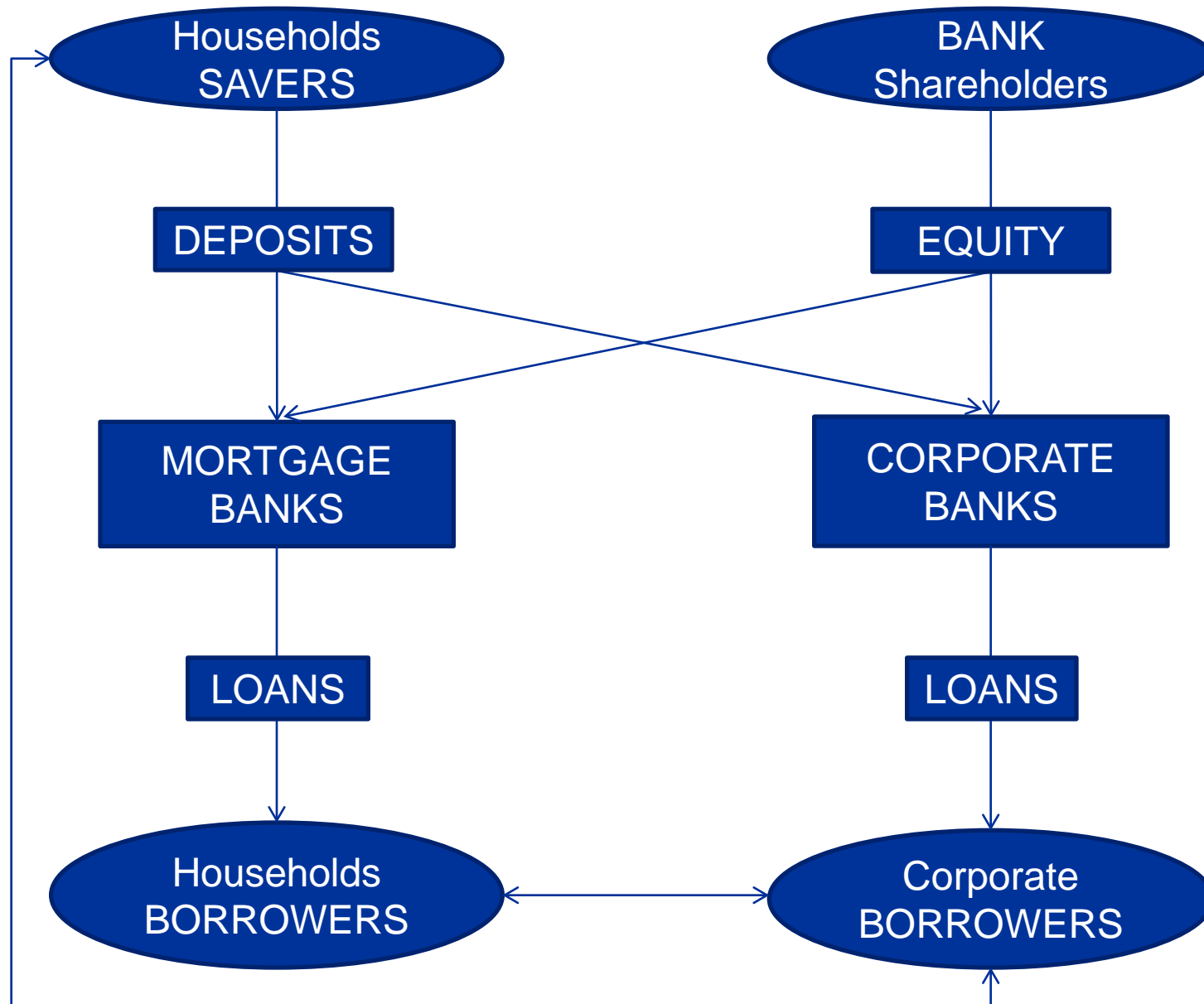

Source: Clerc (BdF), Derviz (CNB), Mendicino (BdP), Moyen (Bundesbank), Nikolov, Stracca (both ECB), Suarez (CEMFI) and Vardoulakis (ECB and Fed Board, 2014).

# MaRs management structure

Chair: Philipp Hartmann, ECB

Work Stream 1 Coordinators:

Laurent Clerc, BdF  
Philipp Hartmann, ECB

Work Stream 2 Coordinators:

Carsten Detken, ECB  
Kateřina Šmídková, CNB

Work Stream 3 Coordinators:

Paolo Angelini, Bdl  
Simone Manganelli, ECB

Consultants:

Professor Xavier Freixas,  
Universitat Pompeu Fabra  
(2010-2012)

Professor Javier Suarez,  
CEMFI, Madrid  
(2012-2014)

Consultant :

Professor Hans Degryse,  
Katholieke Universiteit Leuven  
(2012-2014)

Secretaries:

Angela Maddaloni, ECB, 2010-2011  
Kalin Nikolov, ECB, 2011-2012  
Fiorella De Fiore, ECB, 2012-2013  
Gerhard Rünstler, ECB, 2013

## Work Stream 1

How can financial instability be represented in an aggregate economic model?

How does widespread financial instability affect the real economy?

What are the main transmission channels of financial instability at the aggregate level?

What role is played by nonlinearities, amplification and feedback effects?

What are the cumulative effects of the two-way interaction between financial instability and the performance of the economy at large, including the build-up and unravelling of financial imbalances?

How can the leverage cycle be described theoretically and empirically?

How can these models help understand the causes and features of the recent financial crisis?

How can models help identify the appropriate macro-prudential policies to maintain systemic stability?

## Work Stream 2

What are the key macro-prudential early warning indicators for groups of countries with relatively similar financial structures in the European Union?

How can the different indicators be aggregated at the EU level?

What are the best early indicators of widespread imbalances, asset price bubbles, credit booms and over-indebtedness?

What are the best indicators of current systemic stress or instability?

## Work Stream 3

How large are cross-border bank contagion risks compared to domestic risks?

How significant are the risks of spillovers between different types of intermediaries?

Is bank contagion risk significantly enhanced when feedback effects are taken into account?

Can one distinguish between contagion risk, as one form of systemic risk, and the unravelling of imbalances, the Minsky-Kindleberger type of systemic risk?

# General achievements of MaRs

- Further clarified important **concepts**
- Developed several **structural models** incorporating financial instability into macroeconomics (perhaps main challenge of economics today)
- Proposed a variety of novel **empirical approaches** to
  - **measure widespread financial instability and identify its origins**
  - assess its (often non-linear) interaction with the economy at large and
  - warn about the risk of financial crises
- Started to assess a wide range of **regulatory instruments** proposed for macro-prudential policy
- Developed a number of **analytical tools** for supporting policy
- Put new (European) **data sources** at work

→ **Material progress in developing the analytical foundations of macro-prudential policies**

## ➤ Structural/theoretical

- Aoki and Nikolov, 2012, Bubbles, banks and financial stability, *ECB Working Paper*, No 1495 – non-linear dynamic general equilibrium model with banks holding asset bubbles and multiple equilibria
- Boissay, 2011, Financial imbalances and financial fragility, *ECB Working Paper*, No 1317 – non-linear static general equilibrium model with excessive wholesale funding of financial intermediaries and multiple equilibria
- Boissay, Collard and Smets, 2013, Booms and systemic banking crises, *ECB Working Paper*, No 1514 – non-linear calibrated dynamic general equilibrium model with banks' wholesale funding leading to boom-bust cycles
- Clerc, Derviz, Mendicino, Moyen, Nikolov, Stracca, Suarez and Vardoulakis, 2014, Capital regulation in a macroeconomic model with three layers of default, ECB, *Mimeo.* – calibrated dynamic general equilibrium model with bank, firm and household default and multiple financial frictions
- Dewachter and Wouters, 2013, Endogenous risk in a DSGE model with capital constrained financial intermediaries, *National Bank of Belgium Working Paper*, No 235 – integrating the He and Krishnamurthy approach in non-linear calibrated DSGE model
- De Walque, Pierrard and Rouabah, 2010, Financial (in)stability, supervision and liquidity injections: A dynamic general equilibrium approach, *Economic Journal*, 120(549) – dynamic general equilibrium model with an interbank market and a bank default

## ➤ **Structural/theoretical (cont.)**

- Goodhart, Kashyap, Tsomocos and Vardoulakis, 2012, Financial regulation in general equilibrium, *Banque de France Document de Travail*, No 372 – non-linear static general equilibrium model with bank default and shadow banking

## ➤ **Empirical**

- Hartmann, Hubrich, Kremer and Tetlow, 2012, Melting down: Systemic financial instability and the macroeconomy, ECB, *Mimeo.* – non-linear vectorautoregression model incorporating systemic financial instability

# Refresher on some concepts

- One definition of systemic risk (ECB 2009): Risk that financial instability becomes so widespread that it impairs the functioning of a financial system to the point where economic growth and welfare suffer materially
- Can involve all components of financial systems (“horizontal”)...
  - Intermediaries (including so-called shadow banks),
  - Markets and
  - Market infrastructures...and two-way relationship with the economy at large (“vertical”)
- Macro-prudential policy
  - Oversight/supervision: Public oversight that aims at identifying and containing systemic risks (rather than risks of individual intermediaries or markets)
  - Regulation: Public regulations that aim at maintaining systemic stability



# Forms of systemic risk and analytical approaches

## The systemic risk cube:

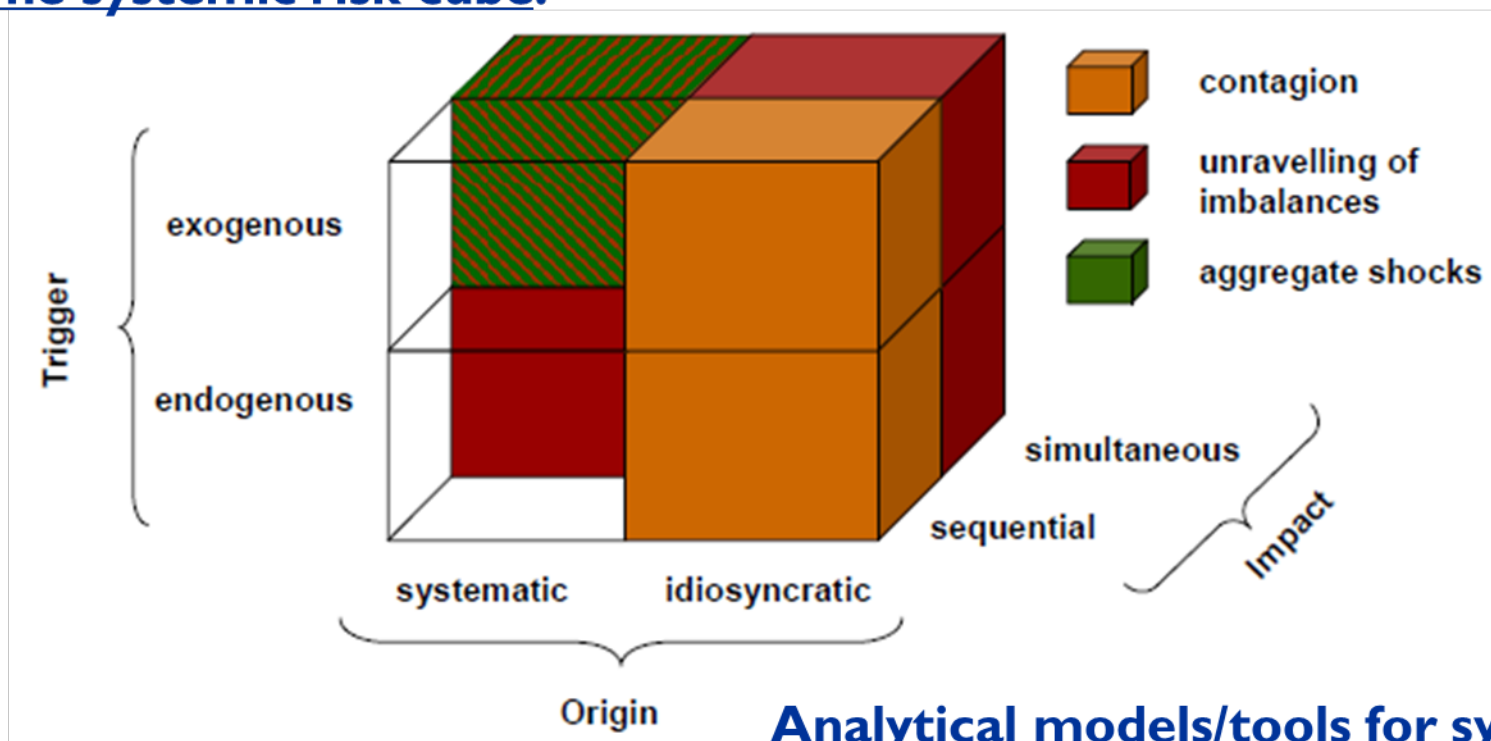

## Analytical models/tools for systemic risk:

- **SR 1: Contagion** – **Contagion and spillover models**
- **SR 2: Endogenous build-up and unravelling of widespread imbalances** – **Early warning indicators and models**
- **SR 3: Aggregate shocks** – **Macro stress testing models**

Source: Based on de Bandt, Hartmann and Peydró (2010) and ECB (2010).

# What can we gain from macro-prudential research?

## Real time euro area GDP growth forecast errors and coincident growth releases

(%)

### a) For 2008

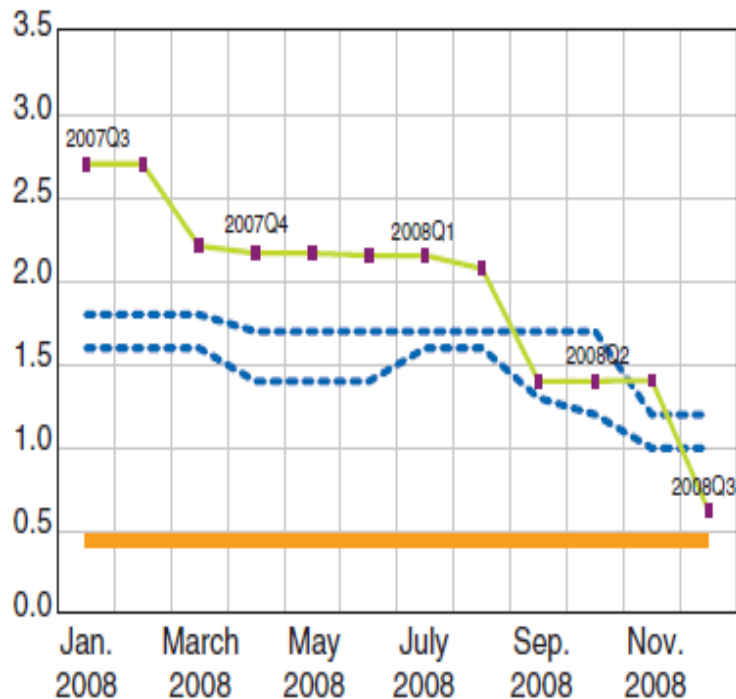

- First release of year on year growth rates (reference period indicated)
- - - Minimum/maximum 2008 forecast
- Annual growth rate 2008 (*ex post*)

### b) For 2009

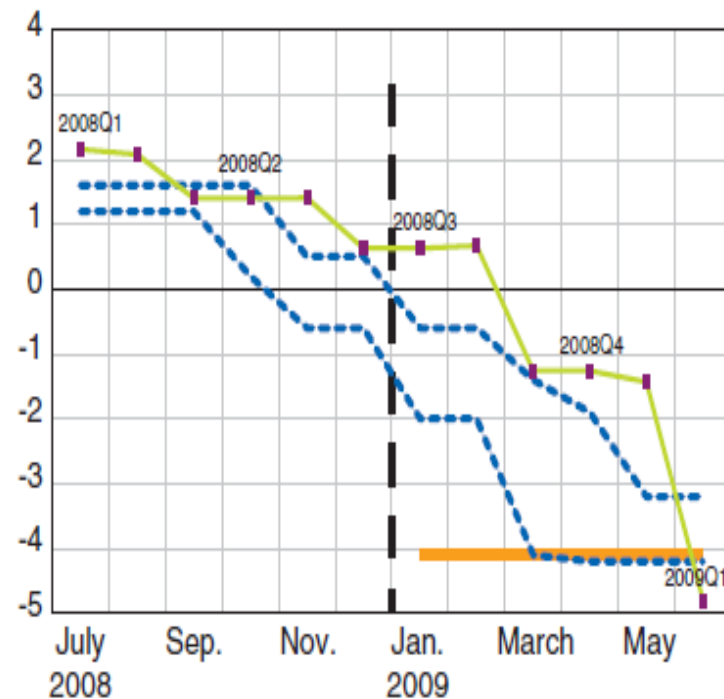

- First release of year on year growth rates (reference period indicated)
- - - Minimum/maximum 2009 forecast
- Annual growth rate 2009 (*ex post*)

Source: Trichet (2011).

# What can we gain from macro-prudential research?

## ➤ Non-linear impact of widespread financial instability on growth

- Take Bayesian vectorautoregression model with output growth, inflation, interest rate and credit growth allowing feedback effects between all variables
- Incorporate our **Composite Indicator of Systemic Stress (CISS)** (see slide 12) in it
- Add **Markov-Switching**/regime changes in parameters and error variances

Output growth ( $\Delta IP$ )

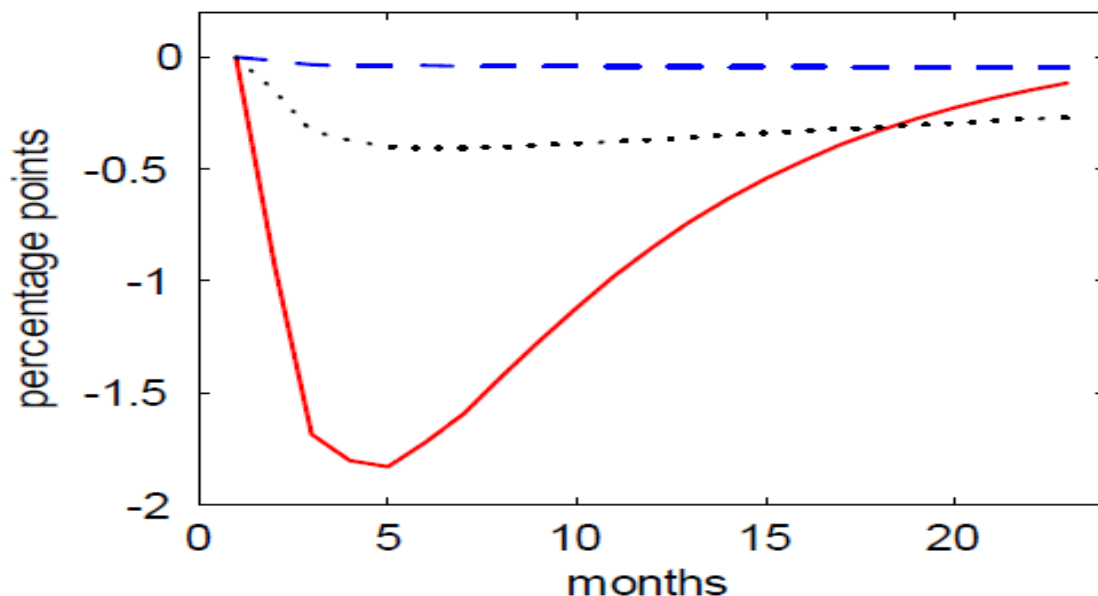

Impulse response functions of a one standard deviation shock in the CISS on output in different regimes (monthly euro area data, 1987-2010)

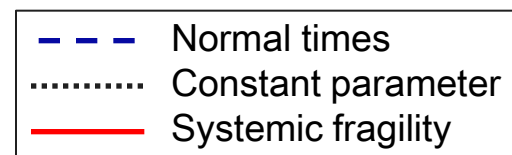

- Nowcasting states of systemic fragility, scenario analyses and, may be, forecasting

Source: Hartmann, Hubrich, Kremer and Tetlow (2012).

## ➤ Non-linear impact of widespread financial instability on inflation

- Markov-switching Bayesian vectorautoregression model with CISS from slide 12
- January 2007 scenario: Large increase of CISS and fundamental regime change to a state of “systemic fragility” (until June 2007)

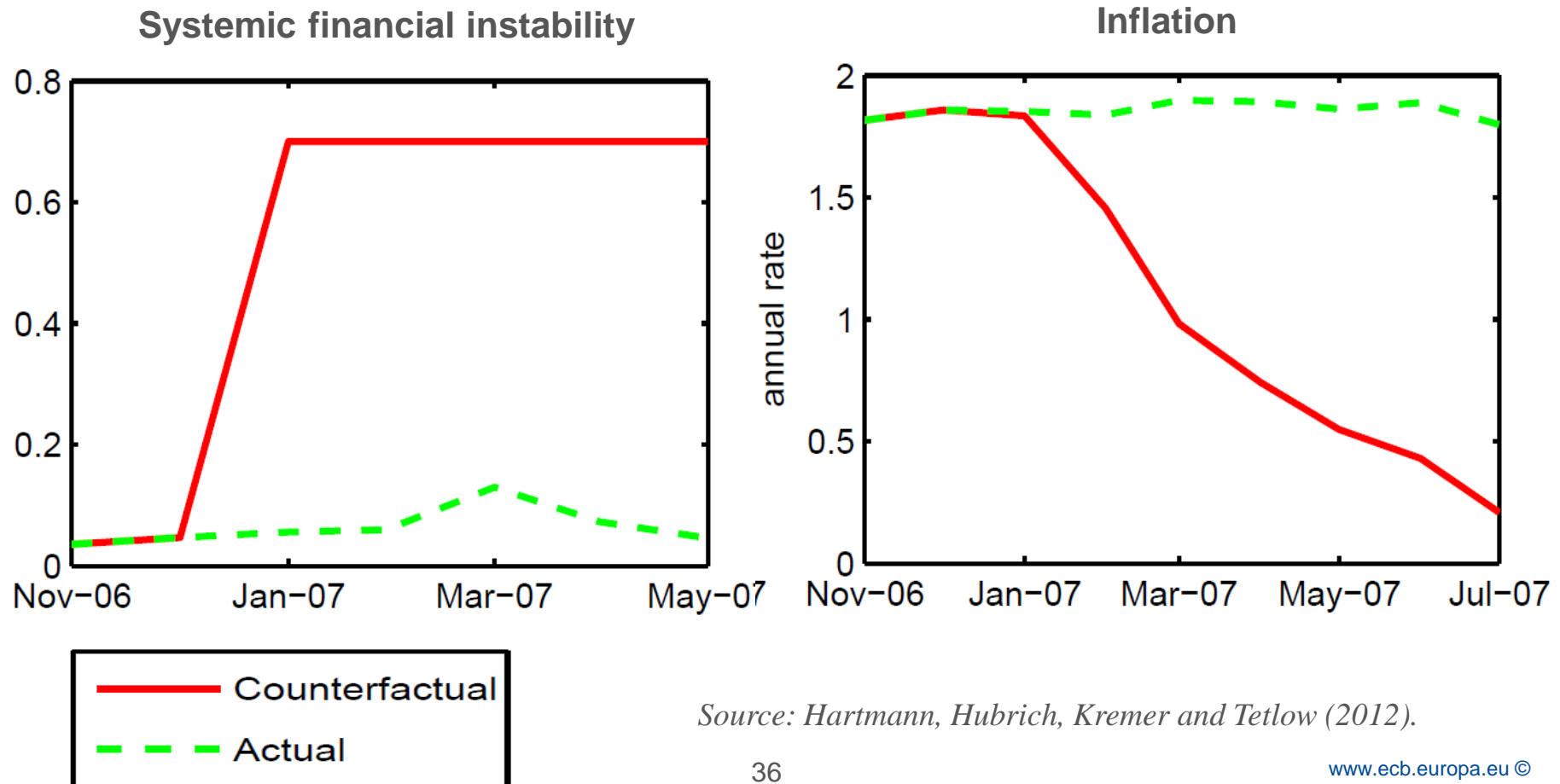

Source: Hartmann, Hubrich, Kremer and Tetlow (2012).

## ➤ Non-linear impact of widespread financial instability on growth

- Markov-switching Bayesian vectorautoregression model with CISS from slide 12
- October 2008 scenario: Fundamental regime change from state of “systemic fragility” to tranquil times (until February 2009)

### Systemic financial instability

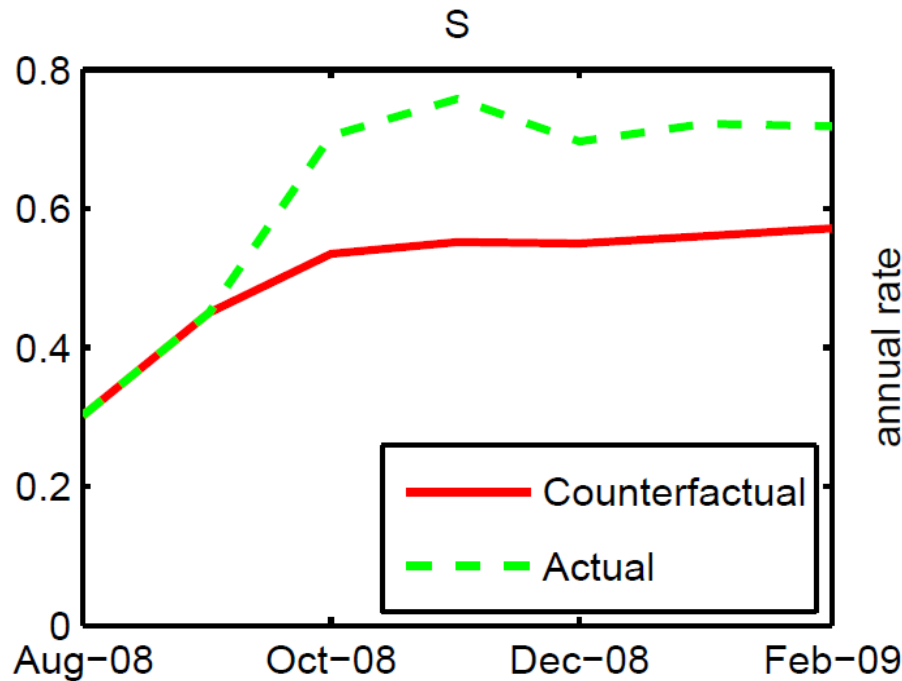

### Output growth

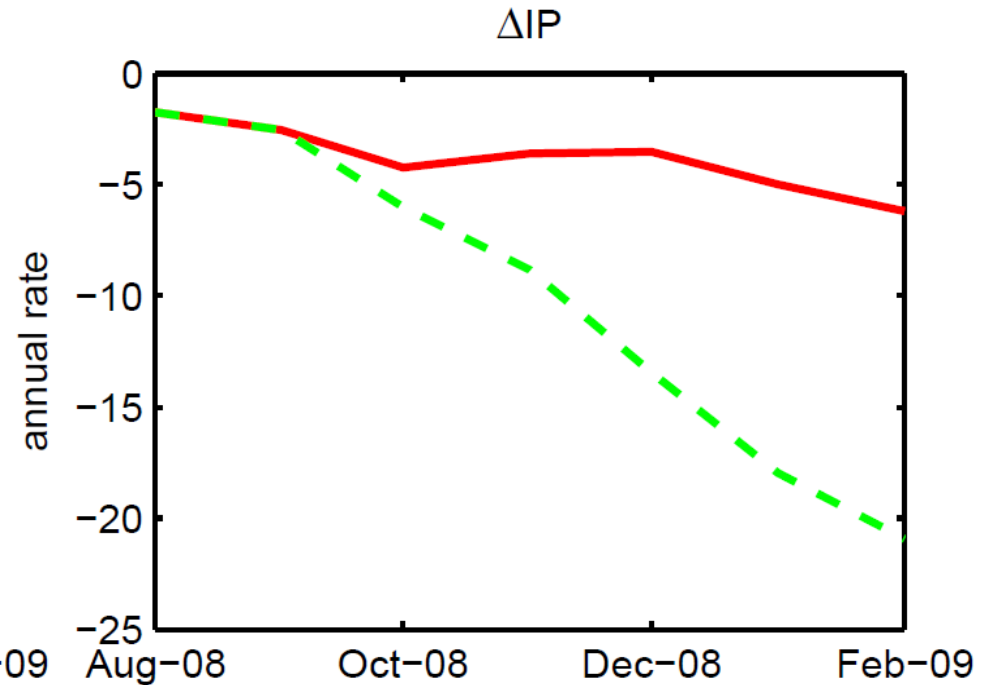

Source: Hartmann, Hubrich, Kremer and Tetlow (2012).

# WS1: Structure of the 3D model

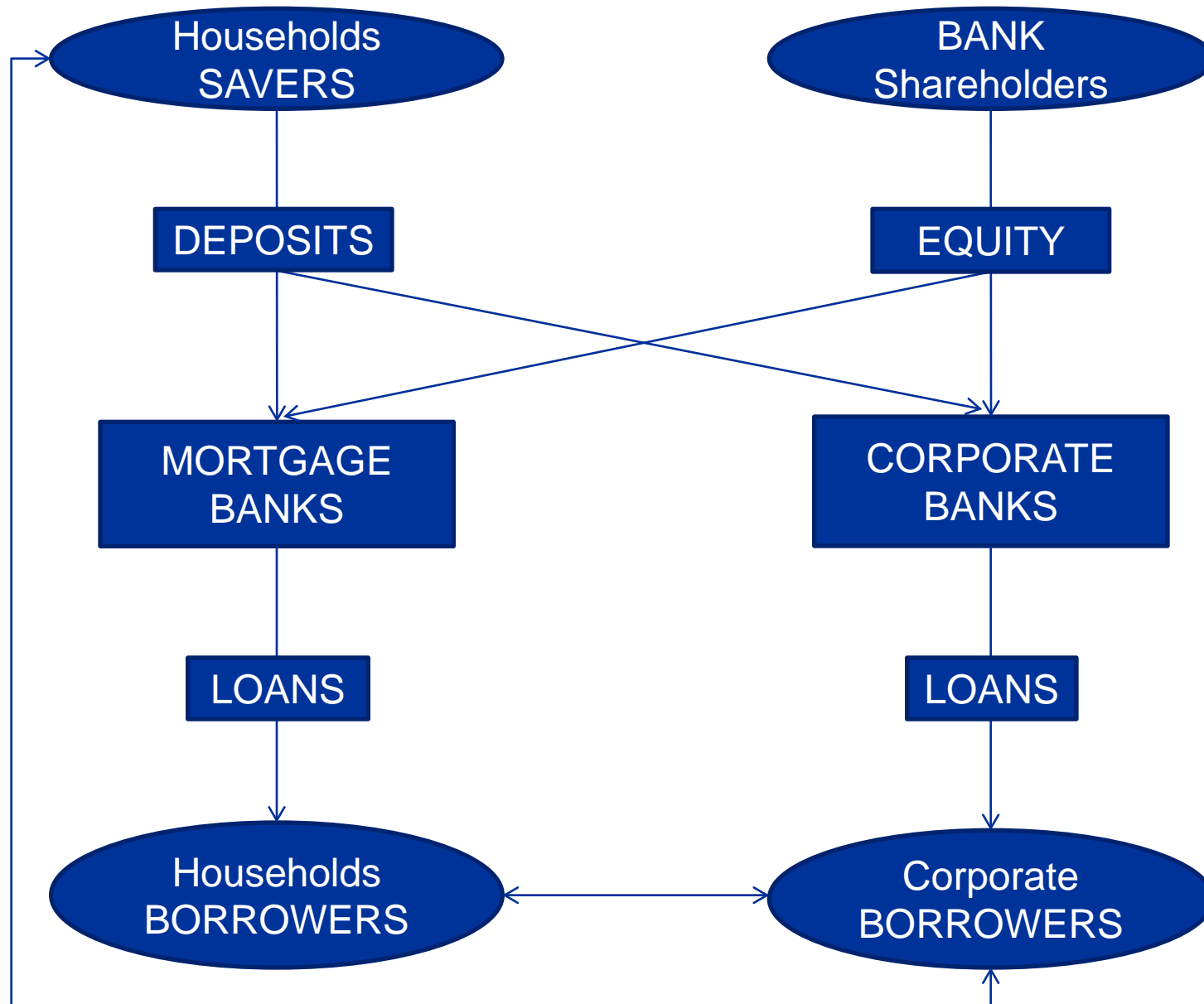

Source: Clerc (BdF), Derviz (CNB), Mendicino (BdP), Moyen (Bundesbank), Nikolov, Stracca (both ECB), Suarez (CEMFI) and Vardoulakis (ECB and Fed Board, 2014).

## ➤ Qualitatively similar conclusions for steady state/medium to long term

- Sizable social benefits of increasing bank capital from low levels
- Limited social costs of relatively high bank capital levels
- **Caveat:** Transitional costs of increasing capital not captured

### Financial crises have permanent GDP effect

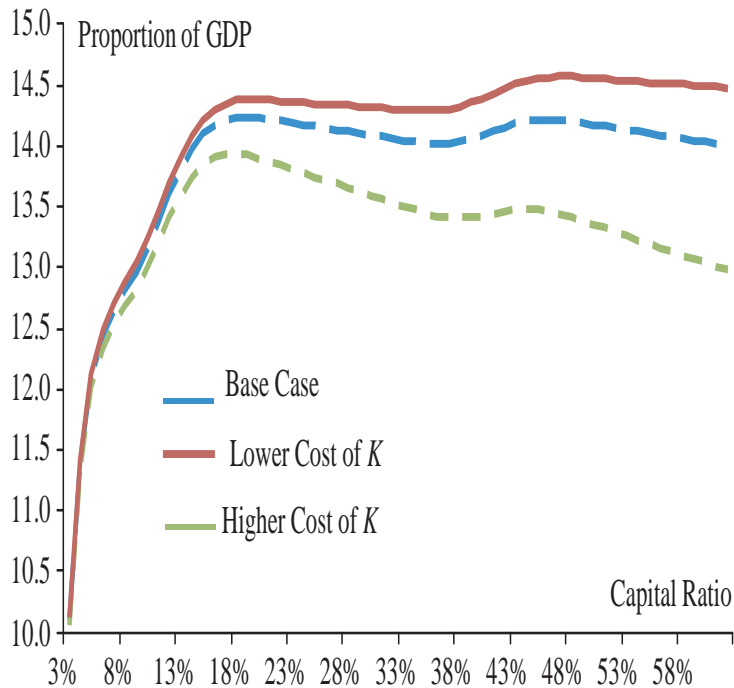

### Financial crises have transitory GDP effect

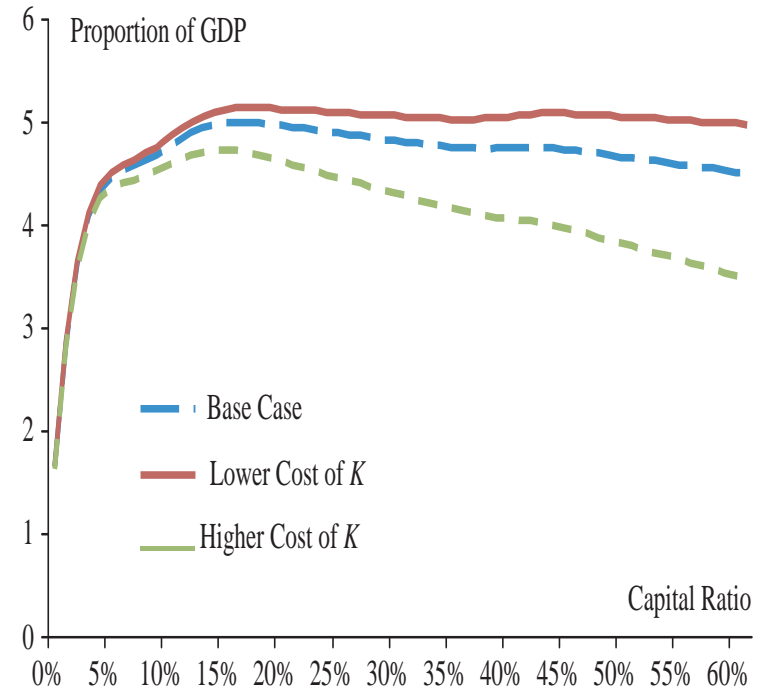

Source: Miles et al. (2012).

## ➤ Qualitatively similar conclusions for steady state/medium to long term

- Sizable social benefits of increasing bank capital from low levels
- Limited social costs of relatively high bank capital levels
- **Caveat:** Transitional costs of increasing capital not captured

### Theoretical measure from 3D

Social Welfare Gains (in terms of consumption) from increasing the Capital Ratio

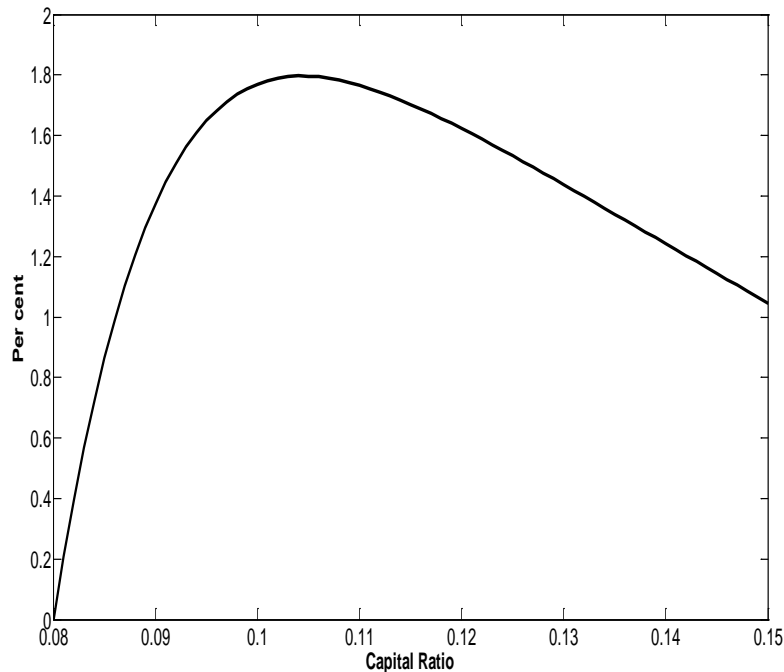

### Empirical measure from Miles et al.

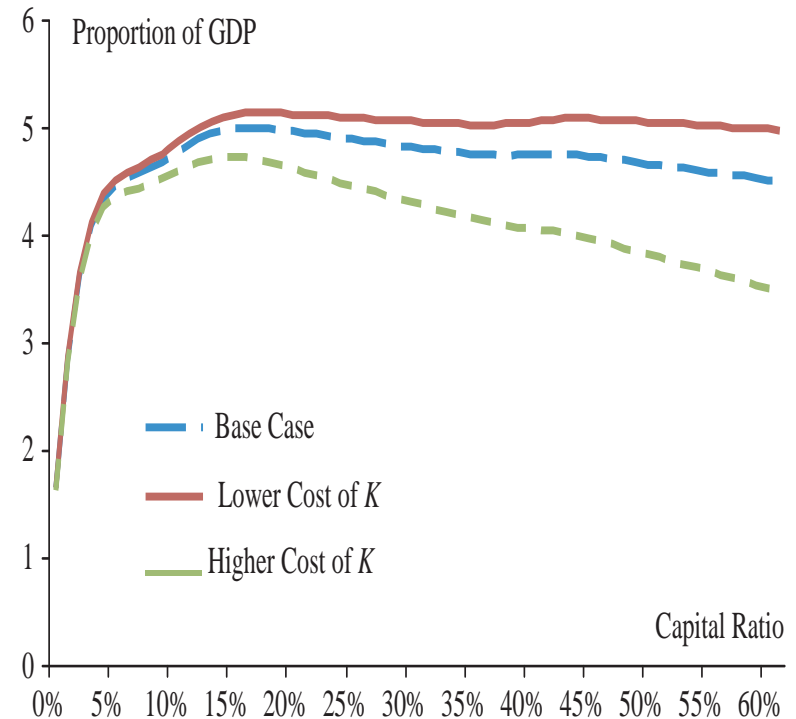



# WS1: Comparison of “optimal” capital levels in the literature

PAPER	OPTIMAL CAPITAL RATIO	GENERAL FRAMEWORK	BENEFITS OF CAPITAL	COSTS OF CAPITAL
<b>Admati and Hellwig (2013)</b>	20+%	Qualitative reasoning based on Modigliani-Miller type partial equilibrium models and corporate finance literature	General discussion of banks' ability to absorb losses, limiting their risk taking, preventing debt overhangs and the associated social benefits	General discussion rejecting reasons why bank capital is costly  (banks can raise equity relatively freely)
<b>Miles, Yang and Marcheggiano (2012)</b>	16-20%	Range of partial equilibrium and ad hoc empirical estimates or models of social benefits and costs of bank equity	Reduced probability of banking crises and therefore their expected output costs	Increased average cost of bank funding and hence borrowing costs for firms and households
<b>Martinez-Miera and Suarez (2012)</b>	14%	Macroeconomic general equilibrium model with moral hazard for banks, for low capital ratios they invest in “correlated/bad” projects	Reduced implicit subsidies associated with deposit insurance, systemic risk taking and bank failures, leading to higher consumption	Reduced credit supply and output  (banks cannot raise outside equity)
<b>MaRs 3D</b>	11%	Macroeconomic general equilibrium model with moral hazard for banks, for low capital ratios they generally lend at too low interest rates and therefore too much to firms and households	Reduced implicit subsidies associated with deposit insurance, over-lending and bank failures, leading to higher consumption	Reduced credit supply and output  (banks cannot raise outside equity yet – extension of the model ongoing)

# WS2: Research questions and main findings

1. What are the key macro-prudential early warning indicators for groups of countries (with relatively similar financial structures in the European Union)?
  - Important to make a distinction between indicators of the **potential sources and transmission of vulnerabilities**.
  - Key **domestic variables**: credit-to-GDP gaps are the best single leading indicators for systemic banking crises associated with excessive credit growth and leverage. Other important indicators measuring asset price misalignments are e.g. house price to income ratio, the growth rate of commercial real estate prices, and the debt service ratio.
  - In addition, WS 2 research also emphasises the importance of **global variables** in early warning models, in particular those related to global credit growth, leverage and asset price misalignments.
2. How can the different indicators be aggregated at the EU level?
  - The WS 2 analysis shows that it is desirable to apply **a suite of early warning models** rather than to try identifying the single best performing model and use it alone. This applies in particular in situations where policy makers' preferences towards type I and II errors are not the same across jurisdictions, stable over time or entirely clear.
3. What are the best early indicators of widespread imbalances, asset price bubbles, credit booms and over-indebtedness?
  - The empirical evidence of WS 2 warns **against relying too much on simple statistical de-trending or filtering methods** to detect imbalances.
  - New developments to detect excessive credit and leverage include e.g. construction of structural or regime switching models. In the area of equity bubbles, factors contributing to mispricing, highlighted by WS2 researchers, include market sentiment and the intensity of herding behaviour.
4. What are the best indicators of current systemic stress or instability?
  - A **composite indicator (CISS)** captures the systemic dimension by being broad in covering stress in the main financial markets and intermediaries and by aggregating these components taking their dependence into account, with their weights linked to their relation to the real economy.
  - This indicator proves to be useful e.g. in guiding the release phase of the countercyclical capital buffer.

- Global empirical study of regional bank fragility and spillovers using market data
- New methodology to disentangle short-term contagion from long-term market integration
- Further progress on applying the network approach at the macro level, using financial accounts
- Network approach to counterfactual simulation of interbank contagion introduces fire sales and shows how they amplify contagion effects in a non-linear fashion

- Range of methodologies: Dynamic factor models, multivariate frequency decomposition, cointegration analysis, forecasting error variance decompositions, dynamic copulas and event studies
- Different data: Sovereign bond yield spreads, sovereign CDS, bank equity returns
- Most papers (but not all) find evidence of sovereign contagion in the euro area since the onset of the debt crisis
- One paper argues that bad news about a country's economy may be confounded with news about a lack of commitment to support it by other countries
- Two papers argue that fundamentals and risk aversion may explain sovereign yield increases

- Most of WS3 TARGET2 related studies focus on interbank loans
- Identification of interbank loans based on Furfine (1999) algorithm (see next slide)
- Two studies have created two alternative data sets:
  - De Frutos, Garcia, Heider and Papsdorf (2013)
    - Focus on overnight transactions, robust to periods of high stress
  - Arciero, Heijmans, Heuver, Massarenti, Picillo and Vacirca (2013)
    - Extract term loans up to 12-month maturity (reliable identification only up to 3m)
- Both studies go at great length to validate the algorithm (using Spanish and Italian trading platforms where interbank loans are observed)
- They find remarkable degree of accuracy (in contrast to a few previous studies on US Fedwire), e.g. comparison with (Spanish) MID trading platform
  - Type I error (false identification of interbank loans): 0.7%
  - Type II error (MID loans not detected): 11.7%

# WS3: Furfine algorithm to identify interbank loans

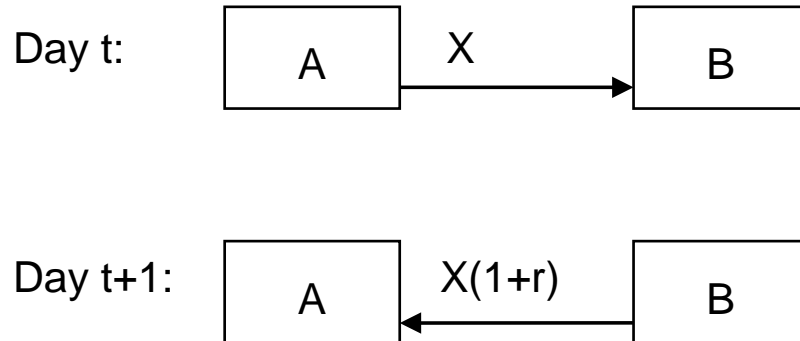

- Payment  $X$  at time  $t$  matched with re-payment at  $t+1$ 
  - Interest rate  $r$  is within certain bounds ( $0, \text{MLF} + 100 \text{ bp}$ )
  - TARGET2 sender-accounts are identical
  - Remove payments within consolidated groups

# WS3: Statistics of TARGET2 data and derived interbank loans

	<b>TARGET2 dataset of unsecured loans</b>	<b>EONIA</b>
Number of loans	Ca. 1 million since June 2008 (ca. 700 loans per day)	Not reported (only aggregate lending rates and volume)
Average daily value	61 billion	32 billion
Banks	392	35 (high activity of Landesbanken)
Coverage	Banks in all TARGET2 countries, allowing analysis at country level	Countries represented only by panel banks

*Source: ECB.*

# WS3: Tracking the interbank market with TARGET2 data

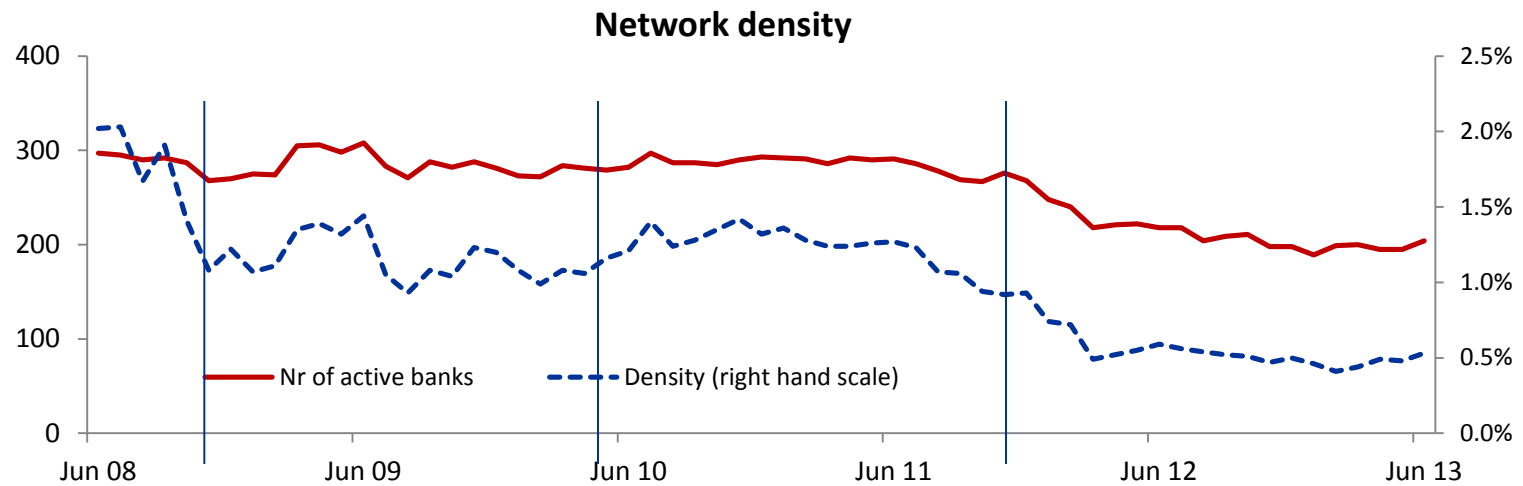
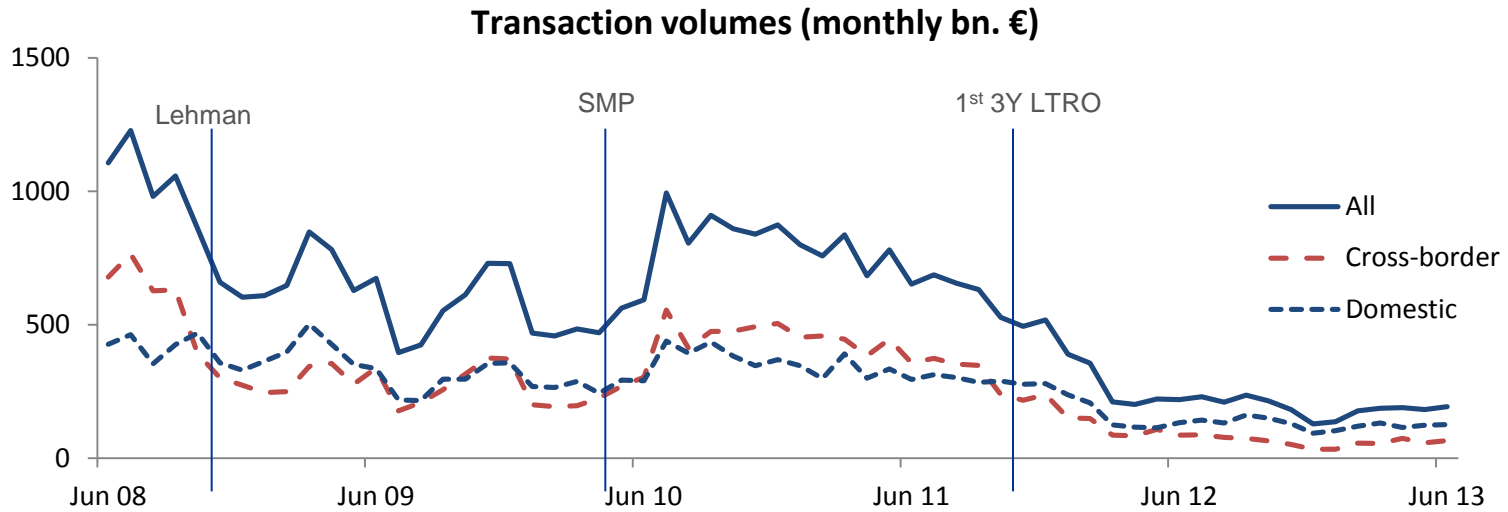

Source: Garcia, Heider and Rünstler (2013).



## Share of overnight loans above marginal lending rate

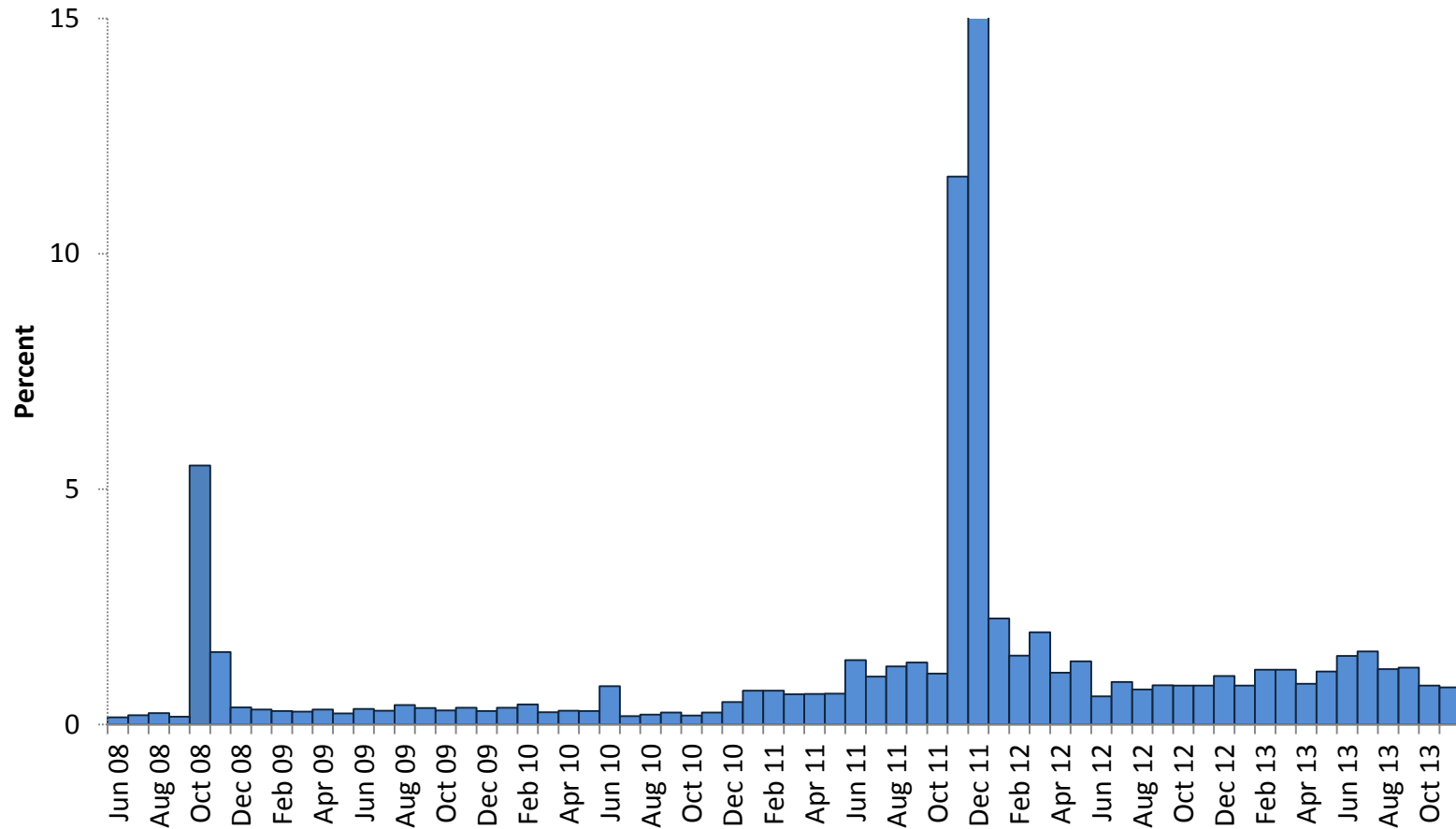

*Monthly percentages of overnight loans identified with TARGET2 data with an interest rate above the ECB marginal lending facility rate.*

*Source: de Frutos, Garcia, Heider and Papsdorf (2013).*

- Use bilateral interbank exposures derived from TARGET2 data and match them with balance sheet data from Bankscope to simulate contagion
- One bank is assumed to fail at a time
- Its contagion effect on other banks is assumed to be
  - the respective bilateral exposure
  - times its loss relative to its equity
  - divided by its tier 1 ratio relative to the average tier 1 ratio among all banks
- Full chain of transmission is calculated for subsequently defaulting and not defaulting banks
- Approach is meant to proxy the idea that other banks may also be affected when no further banks default (“marginal” contagion, e.g. also Ota 2013): Effects through market valuations of assets and liabilities
- At each point in time each bank has a “debt rank”: Sum of the total losses its failure would ultimately cause among all banks in the system as share of total equity in the system

- The banks identified as systemic by the “debt rank” methodology tend to be the largest ones in terms of total assets
- The relationship between size and systemic impact is highly non-linear
- There is significant dispersion in the systemic impact of the largest banks

## ➤ Effect of bank failure on euro interbank network (example Dec. 08)

- Contagion risk larger than found in traditional default simulations
- Largest banks have systemic effect (non-linear) but wide dispersion

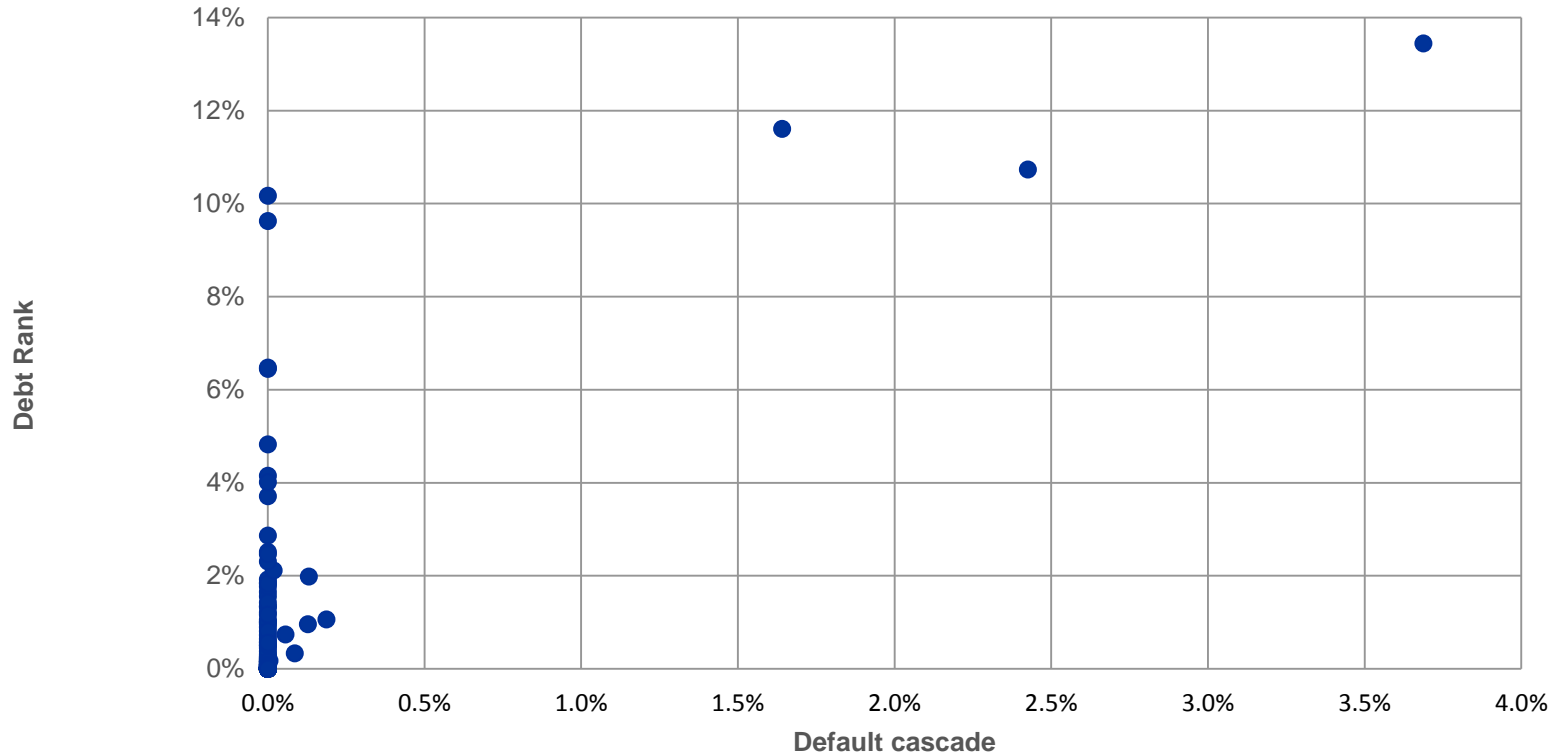

*Simulation of the overall loss of equity among all banks active in TARGET2 caused by individual bank failures (“debt rank” methodology based on a further development of Battiston et al. (2012) compared to “default cascades” based on Furfine (1999)).*

*Source: di Iasio, Rainone, Rocco and Vacirca (2013).*